

For aP89xxxK & aP23xxx

■ **PART NO. : aP23KDBAMP**

■ **PCB NO. : 5201**

■ **PCB SIZE : 87 x 52 mm**

■ **Select your required socket connecting to aP23KDBAMP**

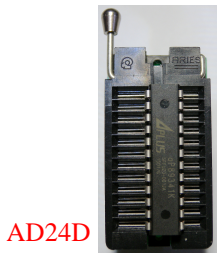
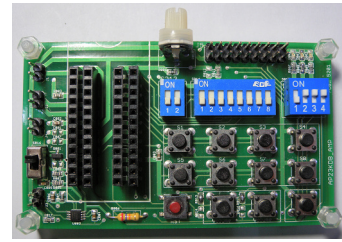

AD24D

Socket for :
aP89682K DIP24
aP89341K DIP24
ap89170K DIP24
aP89085K DIP24



28S-24D

Socket for :
aP89682K SOP28
aP89341K SOP28
aP89170K SOP28
aP89085K SOP28

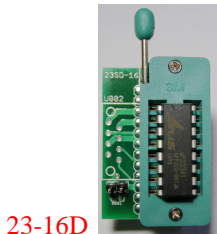

23-16D

Socket for :
aP23682 DIP16
aP23341 DIP16
ap23170 DIP16
aP23085 DIP16

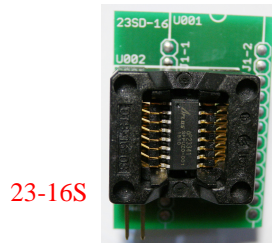

23-16S

Socket for :
aP23682 SOP16
aP23341 SOP16
aP23170 SOP16
aP23085 SOP16

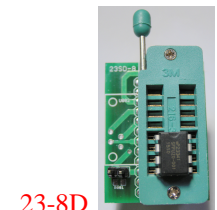

23-8D

Socket for :
aP23682 DIP8
aP23341 DIP8
ap23170 DIP8
aP23085 DIP8

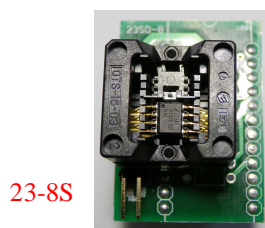

23-8S

Socket for :
aP23682 SOP8
aP23341 SOP8
aP23170 SOP8
aP23085 SOP8

Trigger Mode :

1. aP89xxxK DIP24/SOP28 :

- a. **KEY mode** : S8 ~ S1 & SBT , max. 57 groups
- b. **CPU Parallel mode** : address --- S8(MSB),S7,S6,S5,S4,S3,S2,S1(LSB), total max. 1024 groups & SBT key voice trigger
- c. **MP3 mode** : SBT - Play/Pause, S1- Backward, S2- Forward, S3- Stop, S4- Reset
- d. **SPI mode** : S1(CS), S2(SCK), S3(DI)
- e. **I2C mode** : S2(SCK), S3(DI)
- f. **aP89 mode 1**: Same as aP89341 CPU serial mode
- g. **aP89 mode 2** : aP89mode1 with extra volume control or Crystal Rosc setting

2. aP23xxx DIP16/SOP16 :

- a. **KEY mode** : S4 ~ S1 , max. 13 groups ,SBT sequential max. 1024 groups
- b. **CPU Parallel mode** : address --- S4(MSB), S3,S2,S1(LSB), total max. 16 groups & SBT key voice trigger
- c. **MP3 mode** : SBT - Play/Pause, S1- Backward, S2- Forward, S3- Stop, S4- Reset
- d. **SPI mode** : S1(CS), S2(SCK), S3(DI)
- e. **I2C mode** : S2(SCK), S3(DI)

3. aP23xxx DIP8/SOP8 :
 - a. **KEY mode** : S2 ~ S3 , max. 3 groups , SBT sequential max. 1024 groups
 - b. **CPU Parallel mode** : address --- S3(MSB)~S2(LSB), total max. 4 groups & SBT key voice trigger
 - c. **MP3 mode** : SBT – Play/Pause, S2 – Forward, S3 – Stop
 - d. **I2C mode** : S2(SCK), S3(DI)

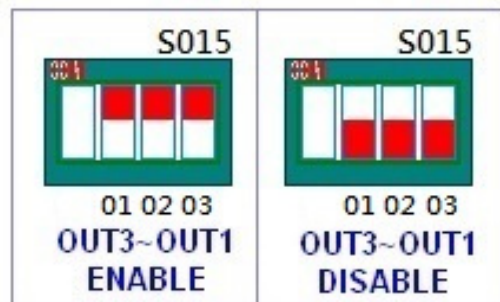
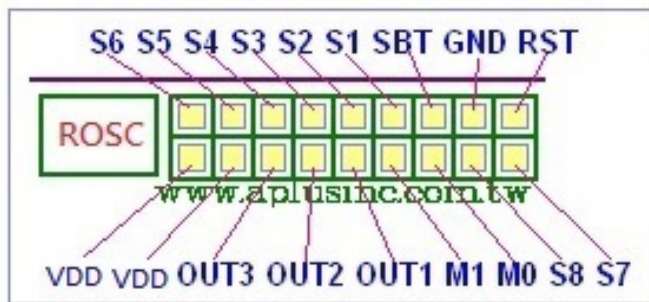
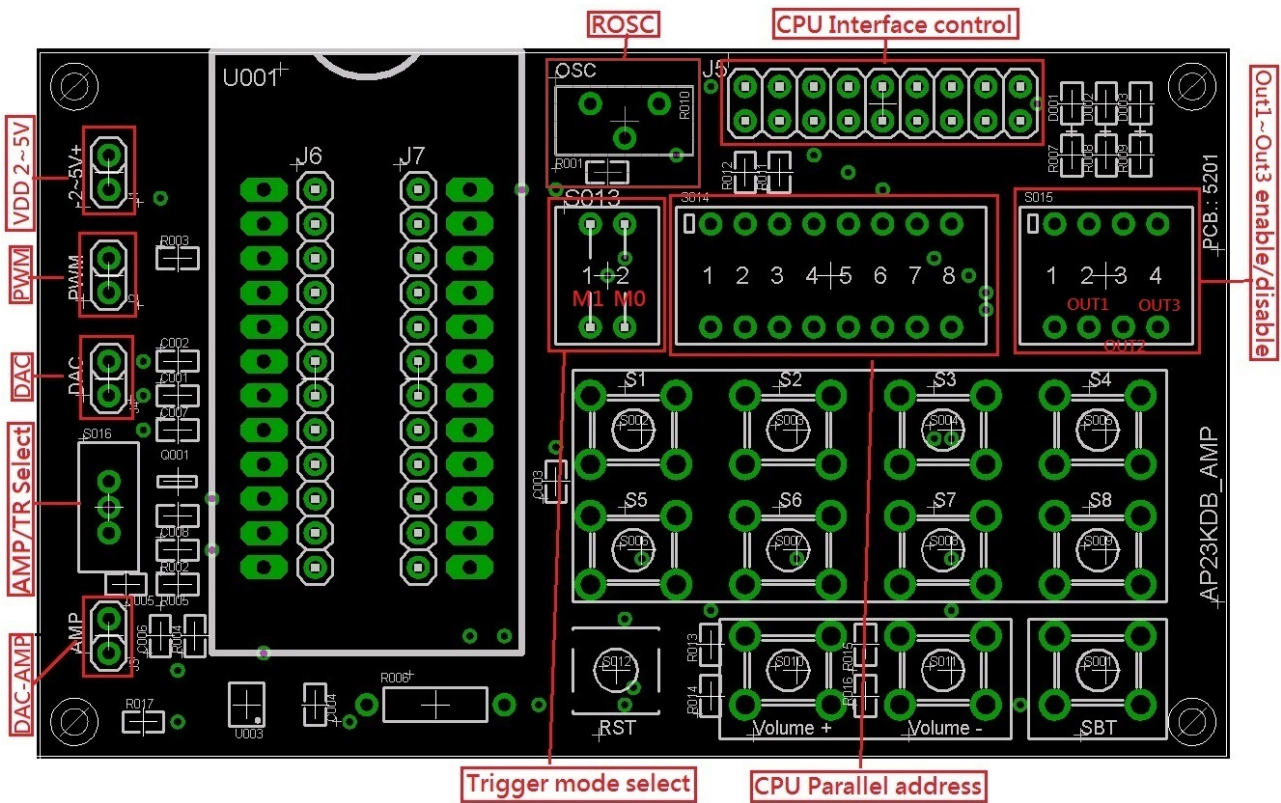

1. KEY TRIGGER : S013 = [M0 = 0 , M1 = 0]

- USE KEY : S1,S2,S3,S4,S5,S6,S7,S8;total max. 57 sections
- SBT KEY : ONE KEY SEQUENTIAL TRIGGER up to 1024 groups
- S015(O3-O2-O1) : ENABLE OUT3,OUT2,OUT1

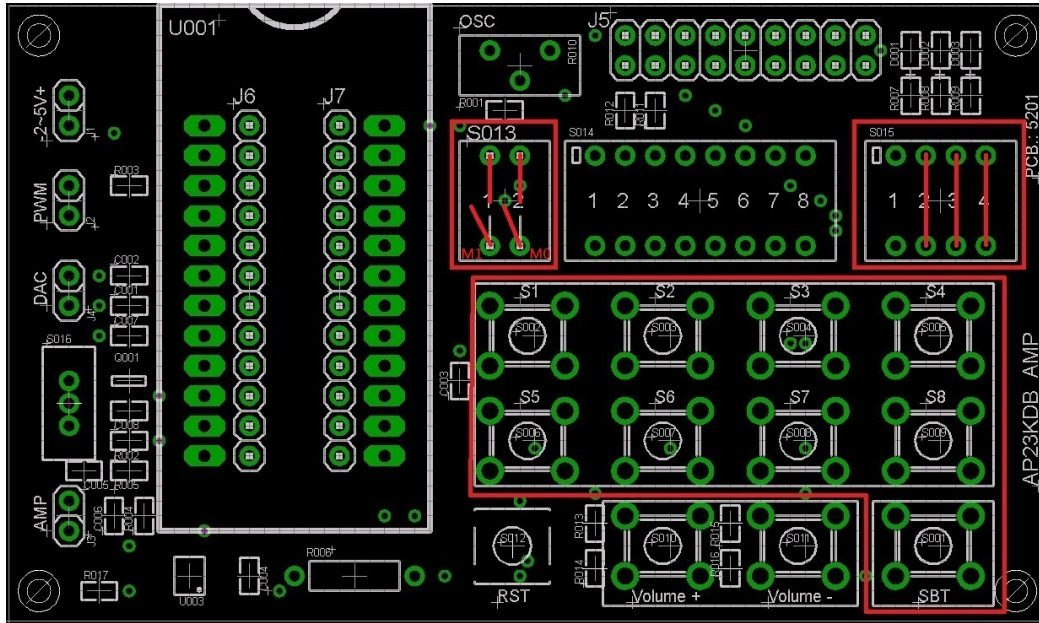

2. MP3 Mode : S013 = [M0 = 1 , M1 = 1]

- USE KEY : SBT - Play/Pause, S1- Backward, S2- Forward, S3- Stop, S4- Reset
- S015(O3-O2-O1) : ENABLE OUT3,OUT2,OUT1

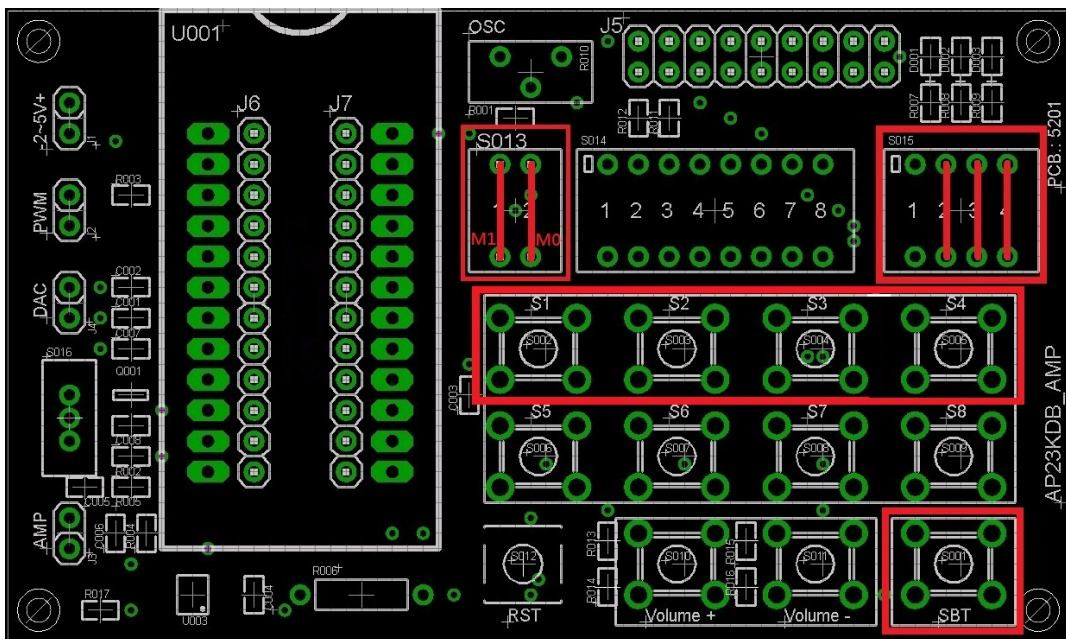

3. Speaker mode select

- PWM & DAC-TR & DAC-AMP

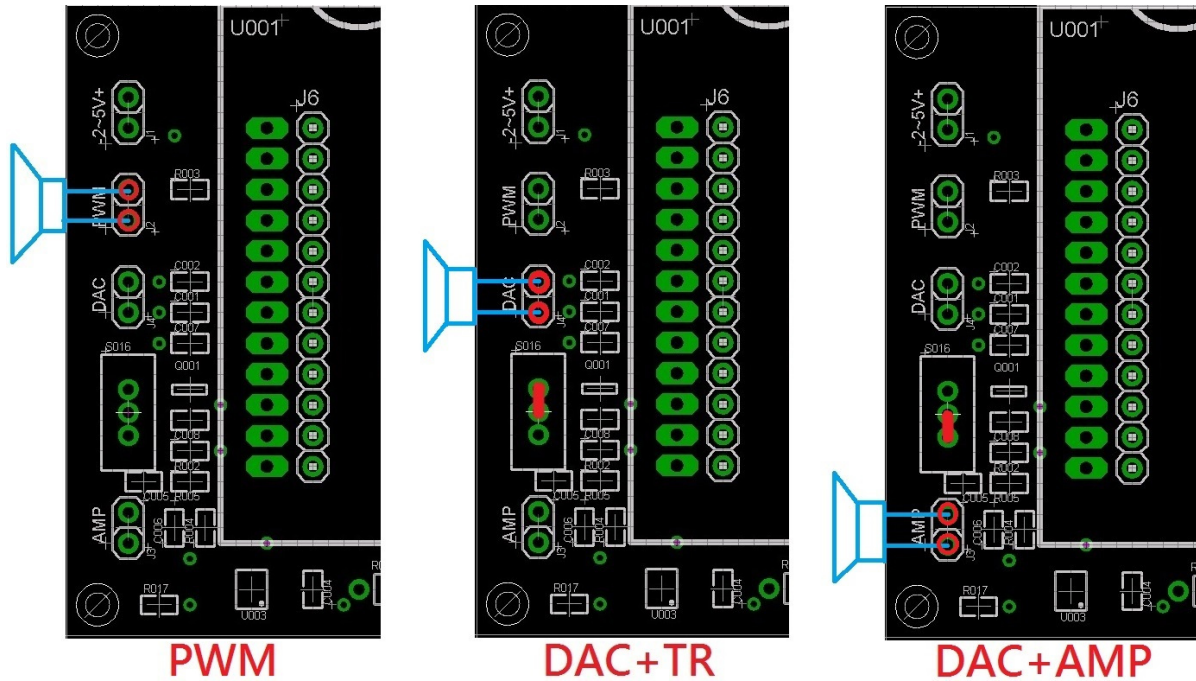

- For more details , please refer to our aP89xxxK & aP23xxx spec :