

IRF30 --- Infrared Range Finder

Overview

IRF30 is an infrared range finder module consisting of a GP2D120 reflective optical sensor module, which emits infrared light to detect the reflective infrared intensity and an Analog-to-Pulse (A2P) Converter board. The A2P Converter board converts the analog output of GP2D120 into pulse width. By measuring the pulse width, the analog readings can be obtained with the PulseIn command. The analog output can also be read directly with the command GetADC command from the I/O Extender module. The recommended detection range is 4~30cm.

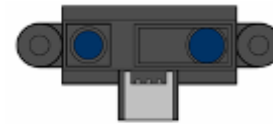

SHARP GP2D120

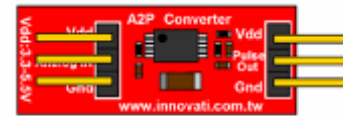

Analog to Pulse (A2P) Converter

Applications

- Short distance range finding
- Proximity detection for collision
- Contactless switch

Features

- Measurement not affected by the color of object
- Analog to Pulse (A2P) module available
- Recommended detection range 4~30cm
- Input voltage 5V
- Compact size for tight space

Connection

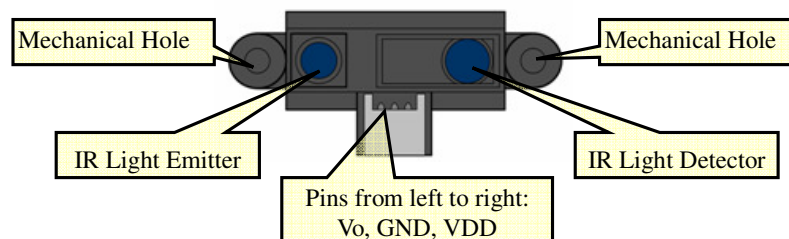

Figure 1 GP2D120 Component Description



Figure 2 A2P Component Description

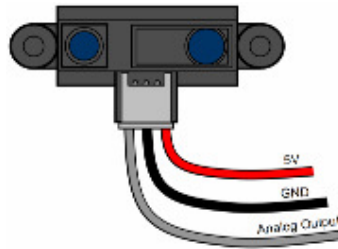

Figure 3 Connecting GP2D120 for analog output

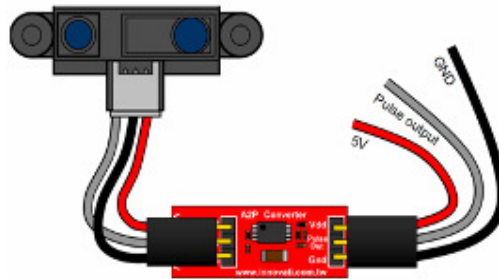

Figure 4 Connecting GP2D120 with A2P for pulse output

Specifications

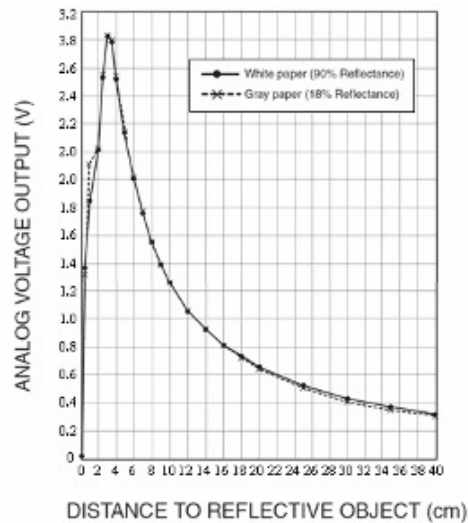

Figure 5 GP2D120 Voltage vs. Distance Characteristic Curve

A2P Pulse Duty

Instead of connecting the analog output to an AD converter to get the GP2D120 analog voltage value, use the A2P Converter module to measure the pulse width directly. The pulse is emitted every 10ms (1ms=1/1000 sec). The low pulse width represents the analog voltage value. Its width varies from 0 to 4096 us (1us=1/1000 ms) with 2us resolution.

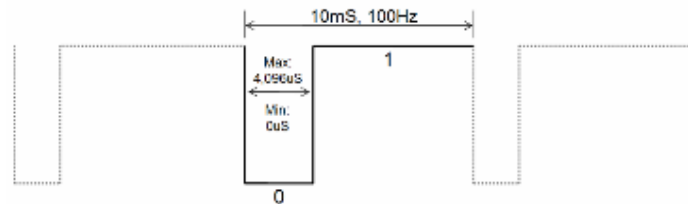

Figure 6 A2P Pulse Duty

The conversion formula is:

$$\text{Width} = V_i(\text{analog input}) / V_{dd} \times 4096 \text{ (us)}$$

Assuming the analog voltage output from GP2D120 is 3V and the supplied voltage is 5V.

Applying the above formula:

$$3 / 5 \times 4096 = 2457.6 \approx 2458 \text{ (us)}$$

the low pulse width will be 2458us.

Dimensions

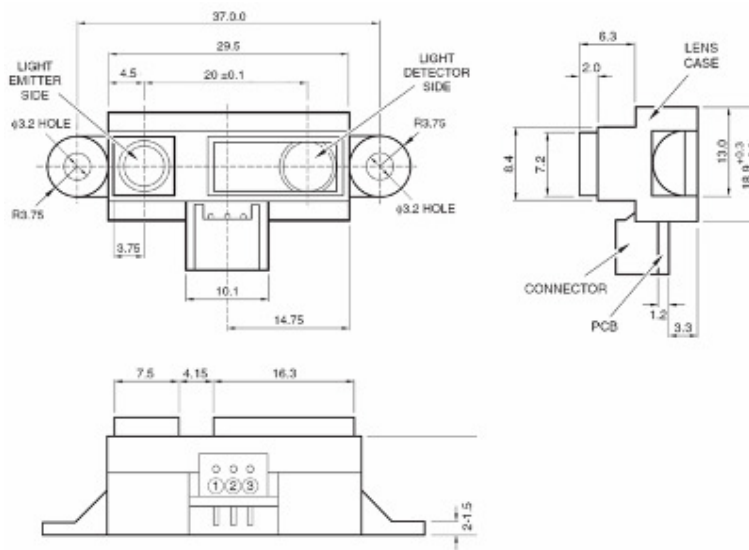

Figure 7 GP2D120 Dimensions

